

P45 SYSTEM

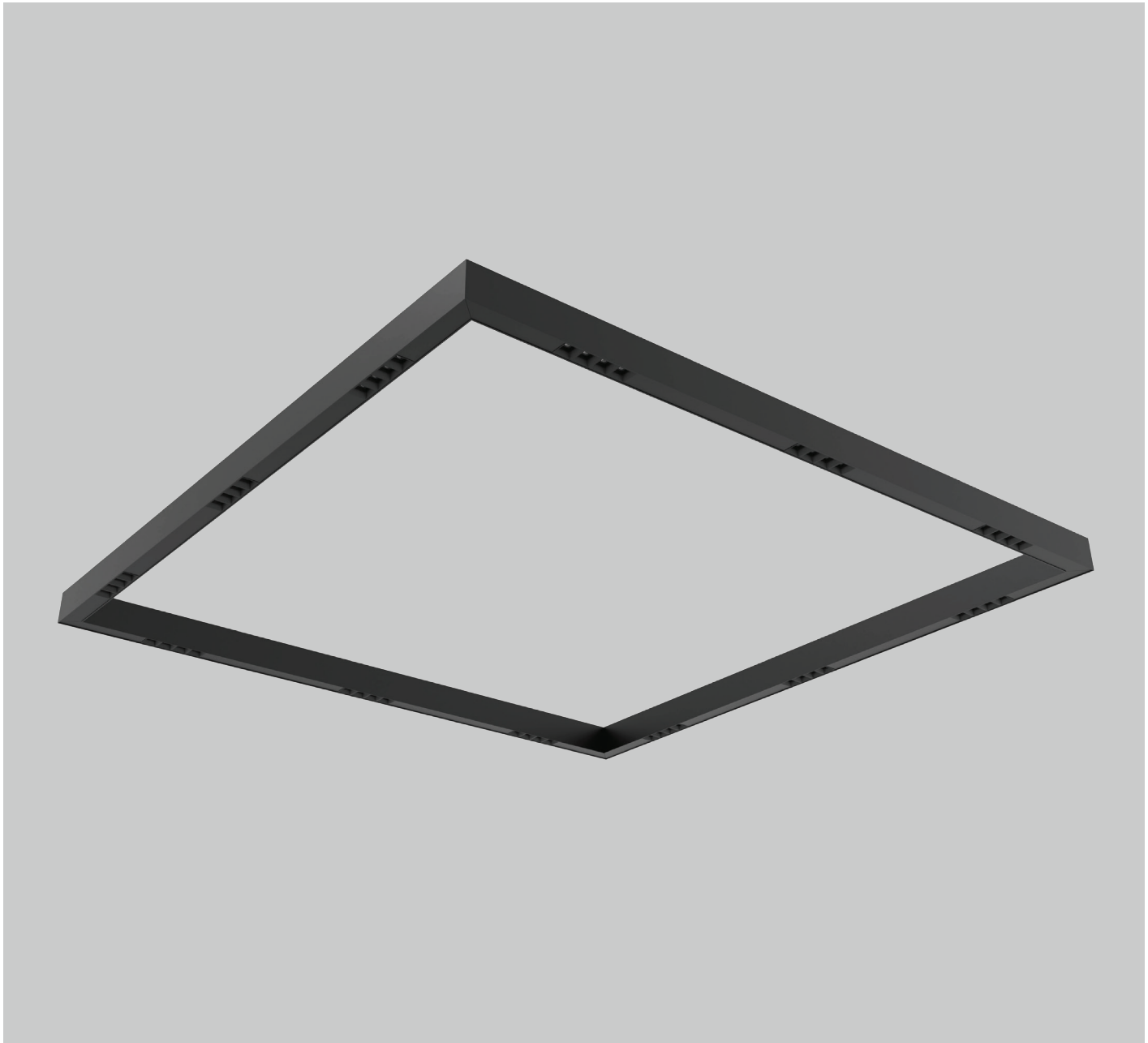

Lighting system made of extruded aluminum profiles. System consists of following components: linear lighting profiles, blind profiles, profiles with build-in 3phase or DALI track, linear and corner connectors. High luminous efficacy optics. Selection of diffusers and low glare UGR<19 lenses. Direct or direct/indirect lighting type. Top quality SMD LED module with colour consistency MacAdams ≤ 3 , extensive portfolio of lumen ranges, CCTs and spectra. Variety of drivers: standard EVG on/off, DALI and wireless controlled as MasterConnect or Casambi on request. Built-in or remote, wireless occupancy & daylight sensor available to allow significant energy savings and wireless connectivity. Mounting type: surface mounted or suspended. Standard colour RAL 9003S, any other colour from basic RAL range available at no extra cost. Variety of beam angles, diffusers, lumen outputs and drivers allows to use this luminaire in different types of lighting projects. Wide selection of system parts allows to build different shapes and sizes of lighting systems. Variety of standard track mounted luminaires can be integrated with P45 lighting system. All system components and accessories such as linear connectors, quick connectors, suspension wires or power cables should be ordered separately. Bespoke lengths and shapes of lighting system available on request. Luminous flux & Luminaire Power tolerance up to 10%. System power consumption depends on components used. Luminous efficacy depends on type of LED's, electronics, optics and diffuser. The most up to date technical parameters can be found on our website and in database of LDT files.

Lighting direction:



PDF datasheet:



P45 SYSTEM

Mounting:	Surface mounted or suspended
Body material:	Aluminium profile
Colour:	Standard white RAL 9003M, other RAL colours on request
Lumen output:	Standard up to 4000 lm/meter of linear lighting, any other on request
LED module:	Signify (Philips), Tridonic or equivalent SMD LED modules
Colour temperature:	3000/4000K/2700-6500K TW other on request
Colour Rendering:	CRI>80 in standard, other on request
Driver:	EVG on-off/DALI/TW DT8/MC (MasterConnect)/Casambi, other on request
Wireless control:	Philips MasterConnect / Casambi, other on request
Daylight/Occupancy sensor:	Built-in XC sensor or wireless MCS sensor
Emergency unit:	On request
Operating temperature range:	0°C ... +35°C
IP Class:	IP20 in standard
Power:	220-240V 50/60Hz
Lighting direction:	Direct, direct / indirect lighting
Light distribution:	Symmetric
Diffusor:	OP opal acrylic / MP19H microprismatic UGR<19
Optics:	White reflector / UGR<19 diffused lenses PREMIUM 1 type
Lens shade:	BM black matt / WM white matt
Beam angle:	35°/50°/80° - all types available in our LDT file database
Warranty:	5 Years standard warranty

P45 SYSTEM DN surface mounted or suspended system profile, light down, OP or MP19H diffusor.

P45 SYSTEM UP_DN suspended system profile, light up&down, OP or MP19H diffusor.

P45 SYSTEM PREMIUM 1 DN surface mounted or suspended system profile, light down, UGR<19 BL lenses.

P45 SYSTEM PREMIUM 1 UP_DN suspended system profile, light up&down, UGR<19 BL lenses.

P45 SYSTEM 3P TRACK DN surface mounted or suspended system profile with built-in 3phase track.

P45 SYSTEM 3P TRACK UP_DN suspended system profile with built-in 3phase track and linear light on top.

P45 SYSTEM DA TRACK DN surface mounted or suspended system profile with built-in DALI track.

P45 SYSTEM DA TRACK UP_DN suspended system profile with built-in DALI track and linear light on top.

P45 SYSTEM L-CON system L shaped corner connector.

P45 SYSTEM T-CON system T shaped connector.



Energy saving MasterConnect wireless lighting control system with daylight and movement detection technology on request.



All current index numbers, lumen outputs, power consumption and many other technical information are available in our 2024 pricelist. Details on wireless lighting control systems on page number 896.



XCS wireless switch



MCS wireless daylight&occ sensor



XC daylight&occ sensor

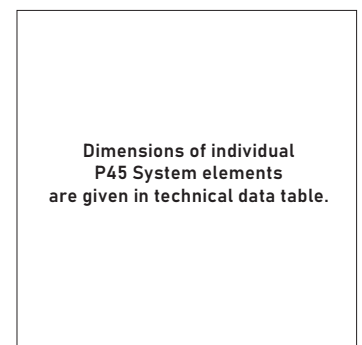

Dimensions of individual P45 System elements are given in technical data table.

Basic dimensions

P45 SYSTEM



OP white acrylic diffuser



MP19H microprismatic UGR<19 diffuser



P45 SYSTEM integrated track



UGR<19 PREMIUM1 4 cell lenses

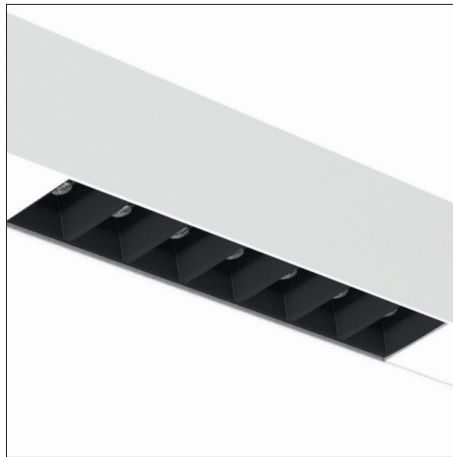

UGR<19 PREMIUM1 7 cell lenses

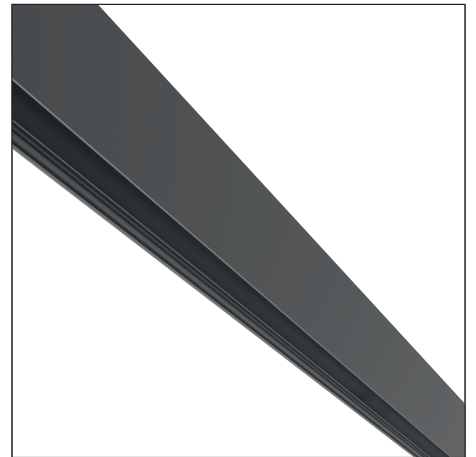

P45 SYSTEM blank profile

Accessories:



Suspension for P45 SYSTEM - 1,5 m long steel wire (1 piece)



3 or 5 core transparent power feed, 1,5 m including ceiling base

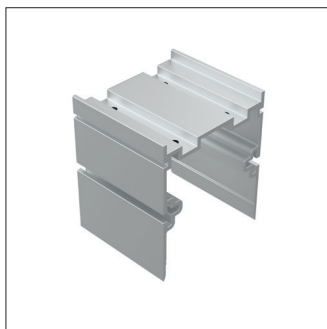

Linear connector for P45 SYSTEM



3 pole quick connectors (Male + Female)

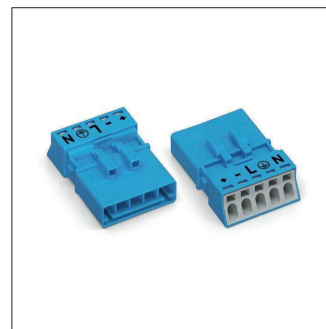

5 pole quick connectors (Male + Female)

P45 SYSTEM

P45 SYSTEM basic profile with light DN or UP_DN - available with OP / MP19H diffusers or PREMIUM 1 lense optics..



P45 SYSTEM profile with 3Phase or DALI track in bottom section and upper section with light UP or blank.

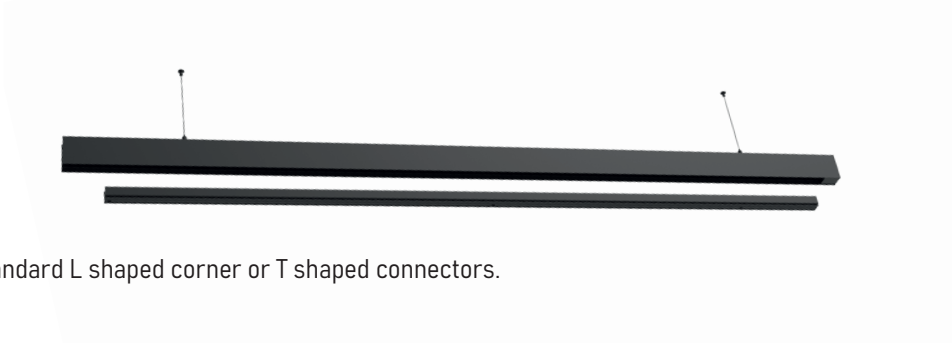

P45 SYSTEM standard L shaped corner or T shaped connectors.

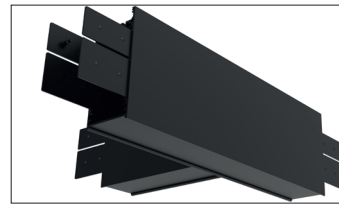
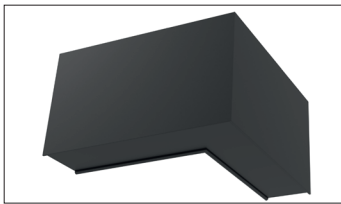

**P45 SYSTEM can be built out of standard system elements or made to measure.
Please contact our sales team for details.**

